

TDT50/TDT150 TDT100/TDT300

Transformer Installation Instructions

THESE INSTRUCTIONS COVER THE INSTALLATION OF THE FOLLOWING OUTPUT TRANSFORMERS FOR 25/70/100 VOLT SPEAKER SYSTEMS

- **TDT50**
50watts Output Transformer for MCA8050 (Single Channel)
- **TDT100**
100watts Output Transformer for MCA8050 (Bridge Channels)
- **TDT150**
150watts Output Transformer for MCA8150 (Single Channel)
- **TDT300**
300watts Output Transformer for MCA8150 (Bridge Channels)

CAUTION – These servicing instructions are for use by qualified personnel only. To reduce the risk of electronic shock, do not perform any servicing other than that contained in the operating instructions unless you are qualified to do so.

NOTE – To avoid fault conditions, High Pass Filters (HPF) must be assigned on those channels having transformers installed.

KIT CONTENTS:

- (1) Transformer
- (1) Holding nut
- (2) rubber washers
- (1) Metal dome washer
- (1) stickers
- (1) Instructions



RECOMMENDED TOOLS:

- Phillips screwdriver
- Adjustable wrench
- Pliers

TDT50 & TDT150 INSTALLATION INSTRUCTIONS

1. Disconnect AC power from the amplifier.
2. Remove the amplifier top panel by removing 17 screws (6 on each side, 3 on back and 2 on front). Please note that front screws are longer.
3. If the mounting bolts have two nuts, remove one and save. These nuts will be used to hold the transformers in place. If the mounting bolts have only one nut, do not remove. Transformer will be held in place with supplied nut.
4. Install transformers as shown in *figure 1*.
5. Locate the amplifier circuit boards and jumpers. Each amplifier card represents two individual output channels; one odd and one even (refer to *figure 2* for reference).
6. Using a pair of pliers, remove the black and red jumper from the associated amplifier channel.
7. Following the diagram below (*figure 3*), connect the wires as indicated.

Please note that wires on odd channel are mirrored from wires on even channel.

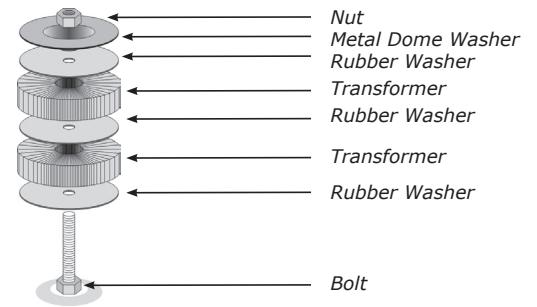

▲ FIGURE 1

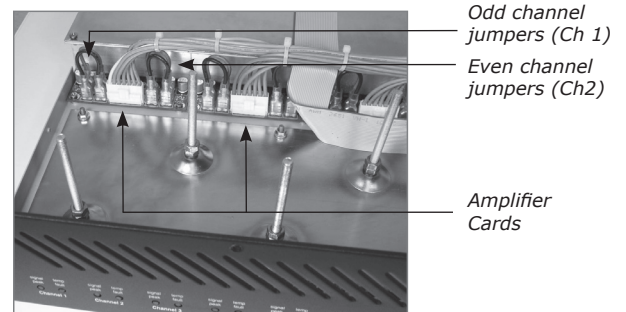

▲ FIGURE 2

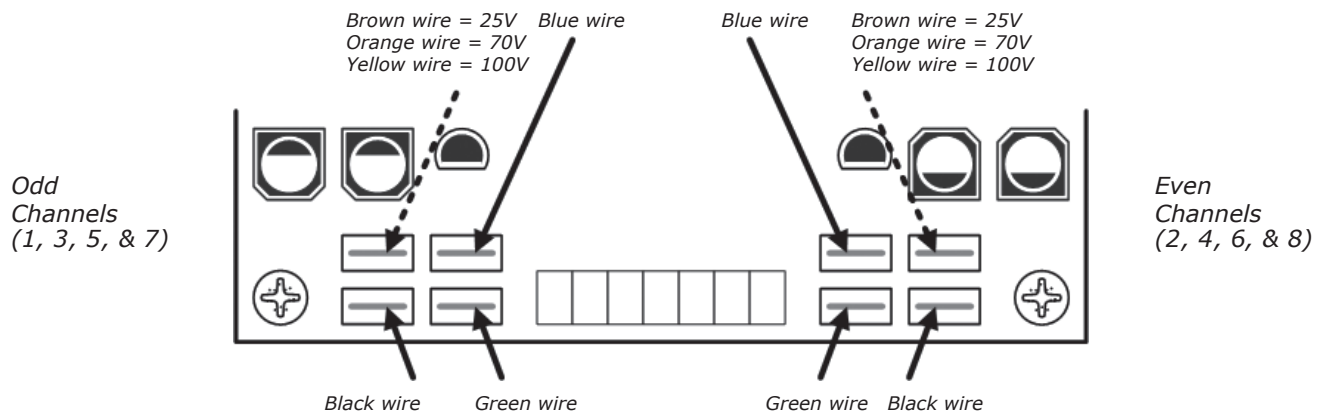

▲ FIGURE 3

8. Replace amplifier top panel (longer screws go on the front).
9. Assign channel HPF (High Pass Filter) by flipping the appropriate channel rear panel dip switch. (*figure 4*)
10. Apply appropriate rear panel "xfmr" voltage sticker. (*figure 5*)

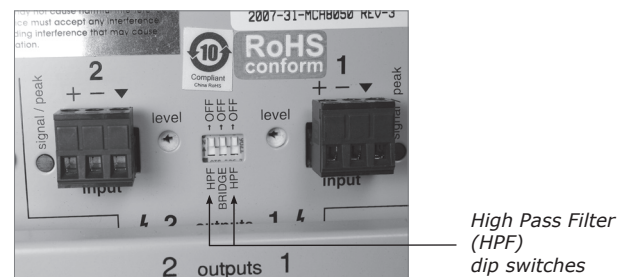

▲ FIGURE 4

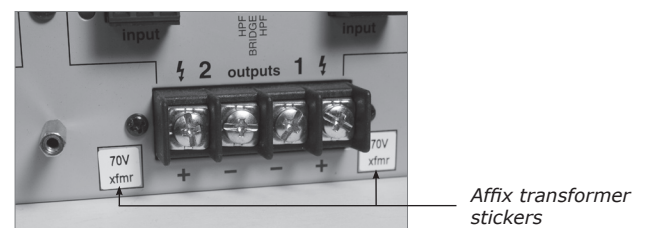

▲ FIGURE 5

TDT100 & TDT300 INSTALLATION INSTRUCTIONS

1. Disconnect AC power from the amplifier.
2. Remove the amplifier top panel by removing 17 screws (6 on each side, 3 on back and 2 on front). Please note that front screws are longer.
3. If the mounting bolts have two nuts, remove one and save. These nuts will be used to hold the transformers in place. If the mounting bolts have only one nut, do not remove. Transformer will be held in place with supplied nut.
4. Install transformers as shown in *figure 6*.
5. Locate the amplifier circuit boards and jumpers. Each amplifier card represents two individual output channels; one odd and one even (refer to *figure 7* for reference).
6. Using a pair of pliers, remove the red jumper from both amplifier channels.
7. Following the diagram below (*figure 8*), connect the wires as indicated.

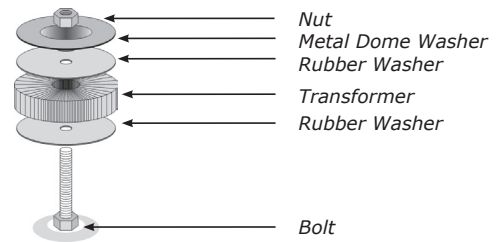

▲ FIGURE 6

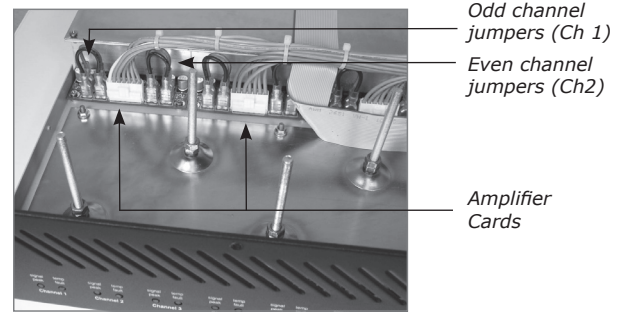

▲ FIGURE 7

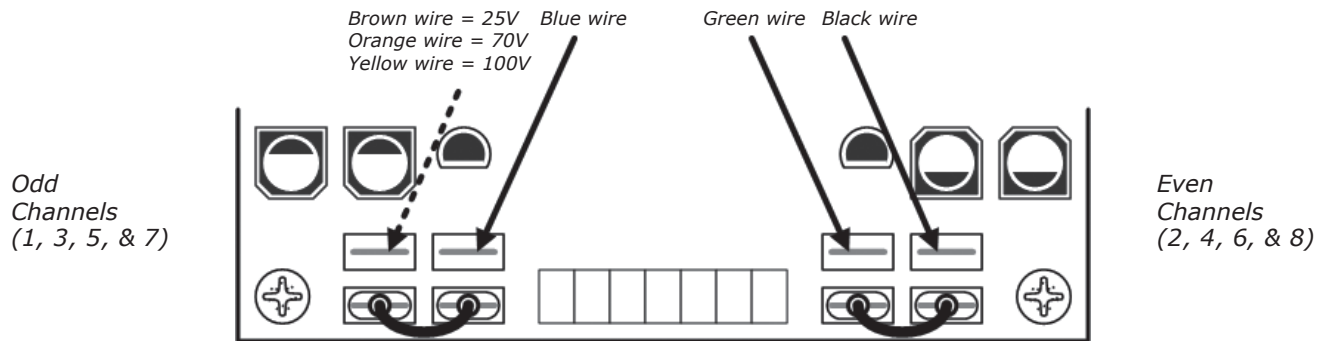

▲ FIGURE 8

8. Replace amplifier top panel (longer screws go on the front).
9. Assign channel HPF (High Pass Filter) by flipping the appropriate channel rear panel dip switch. (*figure 9*)
10. Assign bridge mode by flipping the rear panel bridge dip switch (*figure 9*)
11. Apply appropriate rear panel "xfrm" voltage sticker. (*figure 10*)

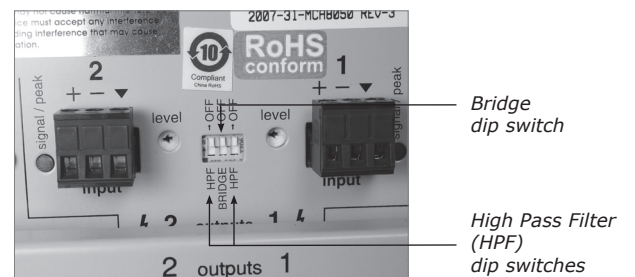

▲ FIGURE 9

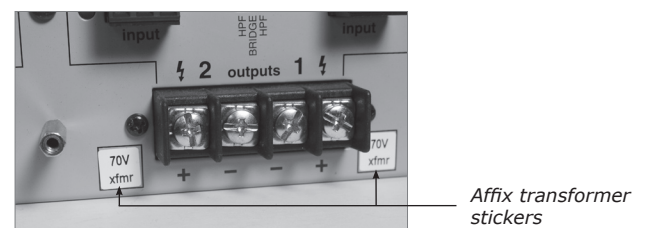

▲ FIGURE 10



EC Declaration of Conformity

Biamp Systems Corporation, as manufacturer having sole responsibility, hereby declares that the following described product complies with the applicable provisions of the DIRECTIVES below except as noted herein. Any alterations to the product not agreed upon and directed by Biamp Systems Corporation will invalidate this declaration.

Product Models: MCA 8050 with optional Output Transformers TDT50 or TDT100
MCA 8150 with optional Output Transformers TDT150 or TDT300

Product Description: Audio Amplifiers and Distribution Transformers

Applicable EC Directives:

Applicable Harmonized Standards:

LVD Directive (2006/95/EC)	Safety	EN 60065:2002
EMC Directive (2004/108/EC)	Emissions	EN 55103-1:1996, Environment E2
	Immunity	EN 55103-2:1996

Special Considerations for Product Environment or Compliance:

Shielded cabling must be used for system connections.

Technical Documentation File, Location and Contact:

Biamp Systems, Inc.	phone:	(503) 641.7287
9300 S.W. Gemini Drive	fax:	(503) 626.0281
Beaverton, OR USA 97008	e-mail:	biamp@biamp.com

Authorized Representative: Larry Copley, Compliance Engineer

Authorized Signature: 

Issued: March, 2010

有害物质表

Biamp Systems

DT-1A、DT-2A、DT-3A、DT-4、TDT50、TDT100、TDT150、DTD300

变压器

部件名称	有毒有害物质或元素					
	Pb (铅)	Hg (汞)	Cd (镉)	Cr+6 (六价铬)	PBB	PBDE
变压器	X	O	X	O	O	O
安装硬件	O	O	O	O	O	O
手册和其他书面文档	O	O	O	O	O	O
包装箱和所有包装材料	O	O	O	O	O	O

O: 表示该部件所有均质材料中的这种有毒有害物质低于 SJ/T11363-2006 的限制要求

X: 表示该部件中至少有一种均质材料所含的这种有毒有害物质高于 SJ/T11363-2006 的限制要求。

除限制销售和使用某些危险物质和制剂的欧盟指令 76/769/EEC 的修正指令-欧盟指令 91/338/EEC 所禁止的用途外，在电触头和（或）镀锡所含的均质材料中，锡及其化合物的含量或许超过 0.01%。

在以下一种或多种物质所含的均质材料中，铅及其化合物的含量或许超过 0.1%:

- 1) 电子元器件中玻璃内。
- 2) 铅作为合金元素的钢材中，铅含量可高达 0.35%。
- 3) 铅作为合金元素的铝材中，铅含量可高达 0.4%。
- 4) 铅作为合金元素的铜材中，铅含量可高达 4%。
- 5) 高熔点类焊料（即含铅量 85%以上的铅基焊料）中。
- 6) 电子陶瓷部件内。
- 7) 由两种以上元素组成、用于连接管脚和微处理器封装、铅含量超过 80%但低于 85%的焊料中。
- 8) 兼容性管脚连接器系统中。
- 9) 倒装芯片封装内半导体芯片及载体之间完成可靠电子连接的焊料中。



在正常使用情况下，中国环保使用期限为 10 年，条件是：

- 环境温度为 0-40°C (32-104°F)
- 湿度为 0-95%，无凝结
- 海拔高度为 0-10,000 英尺
- 空气流通
- 没有水或其他液体进入任何部件
- 电源为 95-265V AC, 50/60Hz
- 部件没有损坏（损坏部件应立即修理）
- 由工厂授权人员使用批准的材料进行所有维修



EU RoHS COMPLIANT

This Biamp product -- including all attendant cables and accessories supplied by Biamp -- meets all requirements of EU Directives 2002/95/EC of January 27, 2003, and 2005/618/EC of August 18, 2005, the EU RoHS Directives. An EU RoHS Materials Content Declaration document may be obtained at <http://www.biamp.com>