

COLUMBIA SERIES
Professional Mixing Console

Owner's Manual



COLUMBIA SERIES

TABLE OF CONTENTS

Controls

Standard Input Channel	pgs. 2 & 3
Stereo Input Channel	pgs. 4 & 5
Submaster	pgs. 6 & 7
Master	pgs. 8 & 9

Connectors

Standard Input Channel	pg. 10
Stereo Input Channel	pg. 10
Submaster	pg. 11
Master	pg. 12

Cables

pg. 13

Power Supply

pgs. 14 & 15

Modifications

pgs. 16 & 17

Specifications

pg. 18

Block Diagram

pg. 19

Warranty

INTRODUCTION

The **BIAMP COLUMBIA Series** mixing consoles provide professional features, solid reliability, and excellent sonic performance in three models. Available in 24, 32, and 40 Input Channel configurations, each with an additional Stereo Input Channel, the COLUMBIA Series mixing consoles are packed with enough features to handle the most demanding professional applications. COLUMBIA 24+/488, 32+/488, and 40+/488 models are compact, with a logical layout of controls and a conveniently located connector panel for ease of operation. All models feature discrete transistor Mic/Line preamplifiers and use 5532 and TLO-72 op-amps throughout the signal path for extremely noise free, high-fidelity performance. All Submaster, Auxiliary Send, Left & Right Main, Mono Main, and Auxiliary Main output circuits are balanced. A rugged assembly, utilizing individual circuit boards and an all metal chassis, provides long-term reliability for either mobile usage or fixed installations.

COLUMBIA Series features include:

- 24, 32, and 40 Input Channel models available
- Discrete transistor Mic/Line preamplifiers for superb sonic quality
- 4 band equalization, with both mid-frequencies sweepable, on each Input Channel
- 8 Auxiliary busses, with 6 Auxiliary controls and output assignment on each Input Channel (includes Send 3 & 4 Pre/Post switch and internal jumpers for all Sends)
- Signal Present and Peak indicators on each Input Channel
- Mic/Line and 20dB Pad switches on each Input Channel
- 48 Volt Phantom Power for condenser microphones and direct boxes
- Direct Output on each Input Channel (Post-Fader)
- Optional input transformers (user installed)
- Additional Stereo Input Channel for tape decks or other stereo line level devices
- 8 Mono and 2 stereo Returns (assignable)
- Auxiliary Left & Right Main outputs with independent level controls
- Solo on all Input Channels, Submasters, Auxiliary Sends, and Auxiliary Mains
- Mute switch on all Input Channels and Submasters
- Patch Insert Points on all Input Channels, Submasters, and Mains
- Balanced outputs on all Submasters, Auxiliary Sends, and Mains
- Stereo Tape output on RCA connectors
- Talkback Mic input with level control and routing assignment
- Headphone Output monitors Left & Right Mains, with automatic Solo interrupt
- Metering assignable to all Submasters, Auxiliary Sends, Mains, and Solo
- External Power Supply with voltage status indicators
- 100mm professional faders

STANDARD INPUT CHANNEL CONTROLS

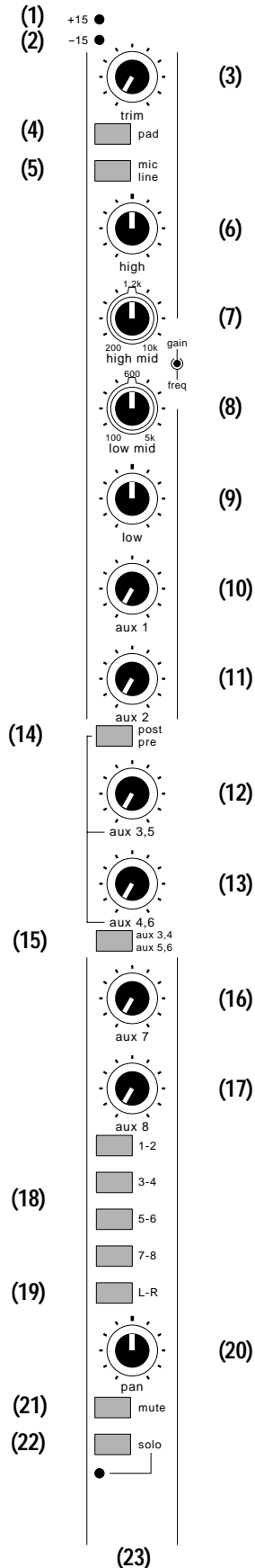

(1) +15 (Peak Indicator): This red LED indicates signal level in the channel has reached +15dB (6dB below clipping). For best performance, adjust the Trim control (3) and Pad switch (4) so the Peak Indicator flashes only on occasional peaks in signal level.

(2) -15 (Signal Present Indicator): This green LED indicates signal level in the channel is above -15dB (normal signal level). Once the Trim control (3) and Pad switch (4) have been adjusted, this indicator will remain lit whenever signal is present in the channel.

(3) Trim: This control provides 40dB of gain adjustment to compensate for different input signal levels. For best performance, adjust this control so the Peak Indicator (1) flashes only on occasional peaks in signal level.

(4) Pad: When depressed, this switch reduces the input signal by 20dB. Use the Pad switch when input signal levels exceed the range of the Trim control (3).

(5) Mic/Line: When released, this switch selects the Mic input as the signal source for the channel. When this switch is depressed, the Line input becomes the signal source for the channel. (See Standard Input Channel Connectors on page 10.)

(6) High: This control adjusts the high frequency equalization (Treble) for the channel. High equalization is a shelving filter with +/-12dB of gain at a fixed frequency of 10kHz.

(7) High Mid: These dual concentric controls adjust the high-mid equalization for the channel. High-Mid equalization is a peaking filter with +/-12dB of gain (upper control) and a center frequency variable from 200Hz to 10kHz (lower control).

(8) Low Mid: These dual concentric controls adjust the low-mid equalization for the channel. Low-Mid equalization is a peaking filter with +/-12dB of gain (upper control) and a center frequency variable from 100Hz to 5kHz (lower control).

(9) Low: This control adjusts the low frequency equalization (Bass) for the channel. Low equalization is a shelving filter with +/-12dB of gain at a fixed frequency of 100Hz.

(10)(11) Aux 1 & Aux 2 (Sends): These controls adjust the level of channel signal sent to the Aux 1 & Aux 2 outputs (see Submaster Controls on page 6). Aux 1 & Aux 2 are post-fader for creating mixes to feed effects devices, tape decks, etc. (see Modifications on page 17).

(12)(13) Aux 3,5 & Aux 4,6 (Sends): These controls adjust the level of channel signal sent to either the Aux 3 & Aux 4 outputs or the Aux 5 & Aux 6 outputs, depending upon the position of the Aux 3,4/Aux 5,6 switch (15) (see Submaster Controls on page 6). Aux 3,5 & Aux 4,6 are post-fader or pre-fader, depending upon the position of the Post/Pre switch (14), for creating mixes to feed effects devices and tape decks, or stage monitors and other sound systems (see Modifications on page 17).

(14) Post/Pre: When released, this switch routes post-fader channel signal to Aux 3,5 & Aux 4,6. When this switch is depressed, pre-fader channel signal is routed to Aux 3,5 & Aux 4,6. (See Modifications on page 17.)

(15) Aux 3,4/Aux 5,6 (Bounce Switch): When released, this switch routes Aux 3,5 & Aux 4,6 signals to the Aux 3 & Aux 4 outputs. When this switch is depressed, Aux 3,5 & Aux 4,6 signals are routed to the Aux 5 & Aux 6 outputs. (See Submaster Controls on page 6.)

STANDARD INPUT CHANNEL CONTROLS

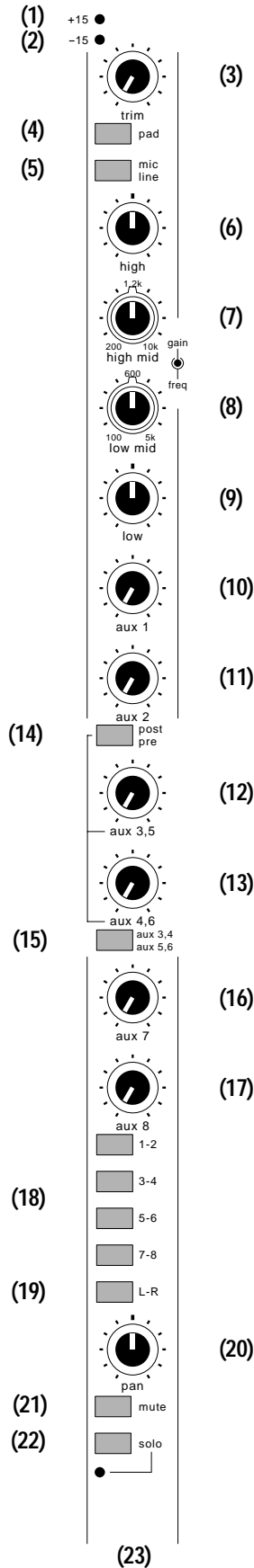

(16)(17) Aux 7 & Aux 8 (Sends): These controls adjust the level of channel signal sent to the Aux 7 & Aux 8 outputs (see Submaster Controls on page 6). Aux 7 & Aux 8 are pre-fader for creating mixes to feed stage monitors, other sound systems, etc. (see Modifications on page 17).

(18) 1-2, 3-4, 5-6, 7-8 (Submaster Assign Switches): When depressed, these switches route post-fader channel signal to the respective submasters (see Submaster Controls on page 7). Each switch selects an odd/even pair of submasters (i.e...1 & 2, 3 & 4, etc.). The amount of channel signal received by the odd or even numbered submasters is determined by the Pan control (20). With the Pan control fully counter-clockwise, only odd numbered submasters receive channel signal. With the Pan control fully clockwise, only even numbered submasters receive channel signal. With the Pan control centered, odd and even numbered submasters receive equal amounts of channel signal. Submaster Assign switches and Pan controls allow related signals, from various channels, to be routed to the same submaster for common control (i.e...vocals to Submaster #1, instruments to Submaster #2, etc.). This arrangement also facilitates mixing for stereo, where the Pan control determines the left/right positioning of channel signal between any selected odd/even pair of submasters.

(19) L-R (Main Assign Switch): When depressed, this switch routes post-fader channel signal directly to the Left & Right Mains (see Master Controls on page 8). The amount of channel signal received by the Left or Right Main is determined by the Pan control (20). With the Pan control fully counter-clockwise, only the Left Main receives channel signal. With the Pan control fully clockwise, only the Right Main receives channel signal. With the Pan control centered, the Left & Right Mains receive equal amounts of channel signal. This arrangement facilitates mixing for stereo, where the Pan control determines the left/right positioning of channel signal between the Left & Right Mains. The Mono Main output provides a sum of the Left & Right Main signals (see Master Controls on page 9). Therefore, when mixing for mono and assigning channels directly to the Left & Right Mains...Pans may be centered to provide mono output from the Left & Right Mains as well...or...Pans may be set full-left and full-right to route related signals to the Left or Right Mains (functioning much like submasters)...or...Pans may be set to create a stereo mix in the Left & Right Mains (for recording) while the Mono Main continues to feed a mono sound system.

(20) Pan: This control determines the amount of channel signal received by the odd or even numbered submasters, and the Left or Right Mains, which have been selected with the Assign switches (18) & (19). Pans may be used either to create stereo mixes or simply to assign channel signals to specific outputs.

(21) Mute: When depressed, this switch turns off channel signal sent to aux sends, submasters, the Left & Right Mains, and the channel Direct Out. Mute does not affect Solo (22) or the channel Patch. (See Standard Input Channel Connectors on page 10.)

(22) Solo: When depressed, this switch routes pre-fader channel signal to the Solo System for monitoring (see Master Controls on page 9). The adjacent green LED indicates when Solo is on. Solo signal is not affected by Mute (21) or the Fader (23). Therefore, channel signal may be monitored even when the channel is muted or turned down.

(23) Fader (not shown): This 100mm slide control adjusts the level of channel signal sent to all selected submasters and Left & Right Mains, as well as to all post-fader aux sends and the channel Direct Out (see Standard Input Channel Connectors on page 10). Fader settings will vary from channel to channel, depending upon the desired mix. However, for best performance, the higher Fader settings should center around the "0" mark (unity gain).

STEREO INPUT CHANNEL CONTROLS

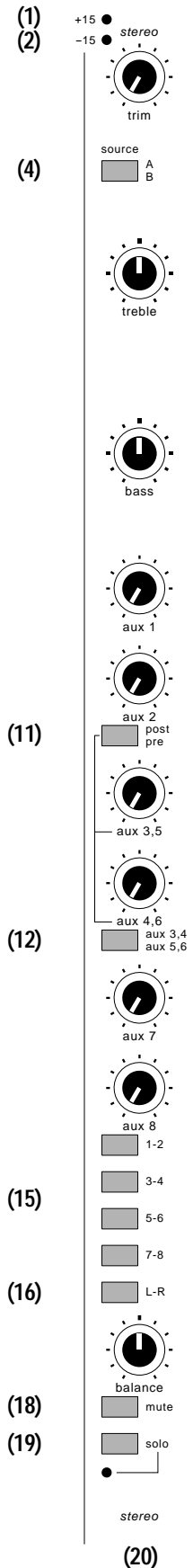

(3)

(5)

(6)

(7)

(8)

(9)

(10)

(13)

(14)

(17)

(1) **+15 (Peak Indicator):** This red LED indicates signal level in the channel has reached +15dB (6dB below clipping). For best performance, adjust the Trim control (3) so the Peak Indicator flashes only on occasional peaks in signal level.

(2) **-15 (Signal Present Indicator):** This green LED indicates signal level in the channel is above -15dB (normal signal level). Once the Trim control (3) has been adjusted, this indicator will remain lit whenever signal is present in the channel.

(3) **Trim:** This control provides 20dB of gain adjustment to compensate for different input signal levels. For best performance, adjust this control so the Peak Indicator (1) flashes only on occasional peaks in signal level.

(4) **Source (A/B):** When released, this switch selects stereo line input "A" as the signal source for the channel. When this switch is depressed, stereo line input "B" becomes the signal source for the channel. (See Stereo Input Channel Connectors on page 10.)

(5) **Treble:** This control adjusts the high frequency equalization (Treble) for the channel, affecting the left & right signals equally. Treble is a shelving filter with +/-15dB of gain at a fixed frequency of 10kHz.

(6) **Bass:** This control adjusts the low frequency equalization (Bass) for the channel, affecting the left & right signals equally. Bass is a shelving filter with +/-15dB of gain at a fixed frequency of 100Hz.

(7)(8) **Aux 1 & Aux 2 (Sends):** These controls adjust the level of channel signal sent to the Aux 1 & Aux 2 outputs (see Submaster Controls on page 6). Aux 1 & Aux 2 are post-fader for creating mixes to feed effects devices, tape decks, etc. (see Modifications on page 17). Aux 1 & Aux 2 are mono sums of the left & right stereo channel signals.

(9)(10) **Aux 3,5 & Aux 4,6 (Sends):** These controls adjust the level of channel signal sent to either the Aux 3 & Aux 4 outputs or the Aux 5 & Aux 6 outputs, depending upon the position of the Aux 3,4/Aux 5,6 switch (12) (see Submaster Controls on page 6). Aux 3,5 & Aux 4,6 are post-fader or pre-fader, depending upon the position of the Post/Pre switch (11), for creating mixes to feed effects devices and tape decks, or stage monitors and other sound systems (see Modifications on page 17). Aux 3,5 & Aux 4,6 are mono sums of the left & right stereo channel signals.

(11) **Post/Pre:** When released, this switch routes post-fader channel signal to Aux 3,5 & Aux 4,6. When this switch is depressed, pre-fader channel signal is routed to Aux 3,5 & Aux 4,6. (See Modifications on page 17.)

(12) **Aux 3,4/Aux 5,6 (Bounce Switch):** When released, this switch routes Aux 3,5 & Aux 4,6 signals to the Aux 3 & Aux 4 outputs. When this switch is depressed, Aux 3,5 & Aux 4,6 signals are routed to the Aux 5 & Aux 6 outputs. (See Submaster Controls on page 6.)

(13)(14) **Aux 7 & Aux 8 (Sends):** These controls adjust the level of channel signal sent to the Aux 7 & Aux 8 output (see Submaster Controls on page 6). Aux 7 & Aux 8 are pre-fader for creating mixes to feed stage monitors, other sound systems, etc. (see Modifications on page 17). Aux 7 & Aux 8 are mono sums of the left & right stereo channel signals.

STEREO INPUT CHANNEL CONTROLS

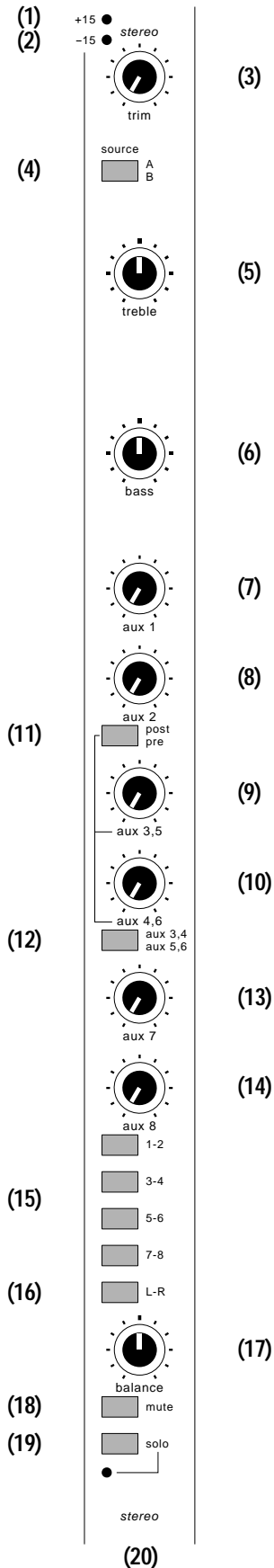

(15) 1-2, 3-4, 5-6, 7-8 (Submaster Assign Switches): When depressed, these switches route post-fader channel signal to the respective submasters (see Submaster Controls on page 7). Each switch selects an odd/even pair of submasters (i.e...1 & 2, 3 & 4, etc.). Odd numbered submasters receive left channel signal only. Even numbered submasters receive right channel signal only. The amount of left or right channel signal received by the odd or even numbered submasters is determined by the Balance control (17). With the Balance control fully counter-clockwise, only odd numbered submasters receive (left) channel signal. With the Balance control fully clockwise, only even numbered submasters receive (right) channel signal. With the Balance control centered, odd numbered submasters receive left channel signal and even numbered submasters receive a proportionate amount of right channel signal. This arrangement facilitates mixing for stereo, where the Balance control determines the left/right positioning of stereo channel signal between any selected odd/even pair of submasters.

(16) L-R (Main Assign Switch): When depressed, this switch routes post-fader channel signal directly to the Left & Right Mains (see Master Controls on page 8). The Left Main receives left channel signal only. The Right Main receives right channel signal only. The amount of left or right channel signal received by the Left or Right Main is determined by the Balance control (17). With the Balance control fully counter-clockwise, only the Left Main receives (left) channel signal. With the Balance control fully clockwise, only the Right Main receives (right) channel signal. With the Balance control centered, the Left Main receives left channel signal and the Right Main receives a proportionate amount of right channel signal. This arrangement facilitates mixing for stereo, where the Balance control determines the left/right positioning of stereo channel signal between the Left & Right Mains. The Mono Main output provides a sum of the Left & Right Main signals (see Master Controls on page 9). Therefore, when mixing for mono and assigning the stereo channel directly to the Left & Right Mains...the Balance control should remain centered to avoid any loss of signal.

(17) Balance: This control determines the amount of left channel signal received by the odd numbered submasters and the Left Main, versus the amount of right channel signal received by the even numbered submasters and the Right Main., which have been selected with the Assign switches (15) & (16). Balance may be used either to shift left/right positioning of the stereo channel signal within a stereo mix, or simply to attenuate left or right channel signals.

(18) Mute: When depressed, this switch turns off channel signal sent to aux sends, submasters, and the Left & Right Mains. Mute does not affect Solo (19).

(19) Solo: When depressed, this switch routes pre-fader channel signal to the Solo System for monitoring (see Master Controls on page 9). The adjacent green LED indicates when Solo is on. Solo signal is not affected by Mute (18) or the Fader (20). Therefore, channel signal may be monitored even when the channel is muted or turned down. Solo is a mono sum of the left & right channel signals.

(20) Fader (not shown): This 100mm dual slide control adjusts the level of channel signal sent to all selected submasters and Left & Right Mains, as well as to all post-fader aux sends. The Fader affects left & right channel signals equally. Fader settings will vary from channel to channel, depending upon the desired mix. However, for best performance, the higher fader settings should center around the "0" mark (unity gain).

SUBMASTER CONTROLS

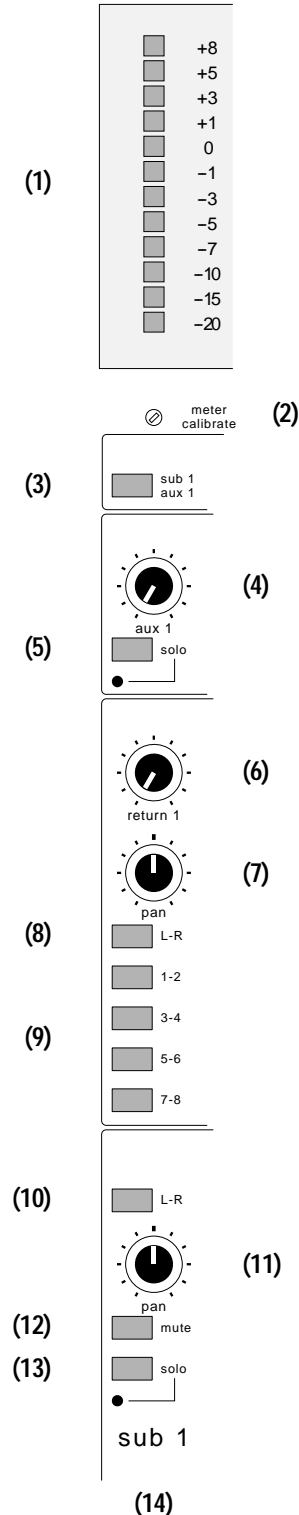

(1) Meter: This twelve-segment, peak reading LED meter displays signal level for the respective Submaster output or Aux output, depending upon the position of the Meter Select switch (3). Meter readings of "0" indicate output levels of +4dBu. When the red "+8" indicator flashes, 15dB of headroom remains before clipping. Headroom is reduced by 6dB when outputs are used unbalanced. (See Submaster Connectors on page 11.)

(2) Meter Calibrate: This control provides screwdriver adjustment of the "0" reference level for the respective Meter. Meter Calibrate is factory set for +4dBu, but may be adjusted to any reference level from -7dBu to +14dBu.

(3) Sub 1-8/Aux 1-8 (Meter Select Switch): When released, this switch routes Submaster output signal to the Meter. When this switch is depressed, Aux output signal is routed to the Meter. (See Submaster Connectors on page 11.)

(4) Aux 1-8: This control adjusts the overall level of signals sent from the respective channel aux sends to the associated Aux output (see Submaster Connectors on page 11). Aux also affects signal sent to the Meter Select switch (3) and Solo (5). For best performance, typical settings of channel & master aux level controls should center around the 11 o'clock position.

(5) Solo: When depressed, this switch routes the respective Aux output signal to the Solo System for monitoring (see Master Controls on page 9). The adjacent green LED indicates when Solo is on. Solo signal is affected by the Aux control (4).

(6) Return 1-8: This control adjusts the level of signal sent from the respective Return input (see Submaster Connectors on page 11) to the submasters and Left & Right Mains, which have been selected with the Pan control and Assign switches (7)(8) & (9). Return is for auxiliary line level signals, such as effects, tape decks, other mixers, etc.

(7) Pan: This control determines the amount of Return signal received by the odd or even numbered submasters, and the Left or Right Mains, which have been selected with the Assign switches (8) & (9).

(8) L-R (Main Assign Switch): When depressed, this switch routes the Return signal directly to the Left & Right Mains (see Master Controls on page 8). The amount of signal received by the Left or Right Main is determined by the Pan control (7). The application of these controls is the same as on the Standard Input Channels (see Standard Input Channel Controls on page 3).

(9) 1-2, 3-4, 5-6, 7-8 (Submaster Assign Switches): When depressed, these switches route the Return signal to the respective submasters. Each switch selects an odd/even pair of submasters (i.e., 1 & 2, 3 & 4, etc.). The amount of Return signal received by the odd or even submasters is determined by the Pan control (7). The application of these controls is the same as on the Standard Input Channels (see Standard Input Channel Controls on page 3).

SUBMASTER CONTROLS

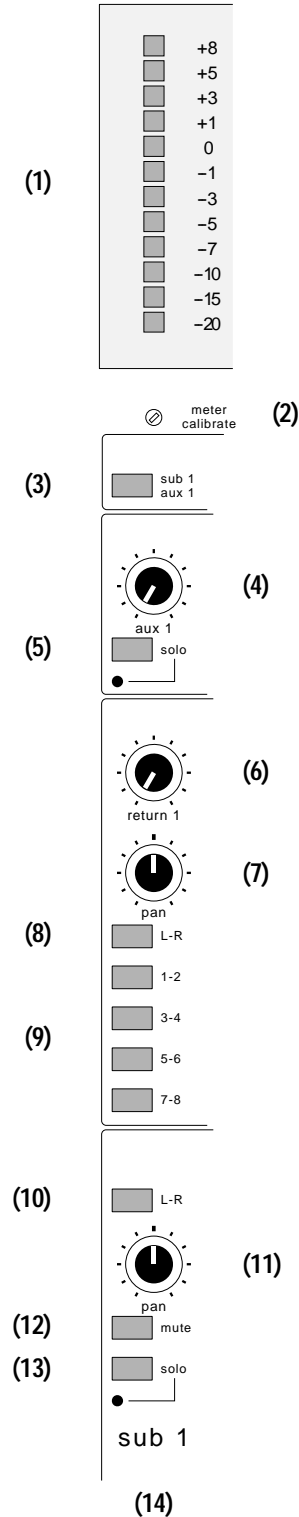

(10) L-R (Main Assign Switch): When depressed, this switch routes post-fader signal from the respective submaster to the Left & Right Mains (see Master Controls on page 8). The amount of submaster signal received by the Left or Right Main is determined by the Pan control (11). The application of these controls is the same as on the Standard Input Channels (see Standard Input Channels on page 3). *NOTE:* An input channel or return signal may be assigned (in mono) to a submaster, which in turn may be assigned (in stereo) to the Left & Right Mains. Likewise, an input signal may be assigned (in stereo) to two submasters, which in turn may be assigned (in mono) to the Left & Right Mains. *CAUTION:* If an input channel or return signal is assigned to a main output, *both directly and through a submaster*, an increase in level will occur.

(11) Pan: This control determines the amount of submaster signal received by the Left or Right Main, when selected with the Main Assign switch (10).

(12) Mute: When depressed, this switch turns off submaster signal sent to the respective Submaster output, the Left & Right Mains, the Meter Select switch (3), and Solo (13). Mute does not affect the submaster Patch (see Submaster Connectors on page 11).

(13) Solo: When depressed, this switch routes post-fader submaster signal to the Solo System for monitoring (see Master Controls on page 9). The adjacent green LED indicates when Solo is on. Solo signal is affected by Mute (12) and the Fader (14).

(14) Fader (not shown): This 100mm slide control adjusts the level of submaster signal sent to the respective Submaster output, the Left & Right Mains, the Meter Select switch (3), and Solo (13). Fader settings will vary from submaster to submaster, depending upon the desired mix. However, for best performance, higher Fader settings should center around the "0" mark (unity gain).

MASTER CONTROLS

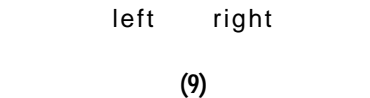
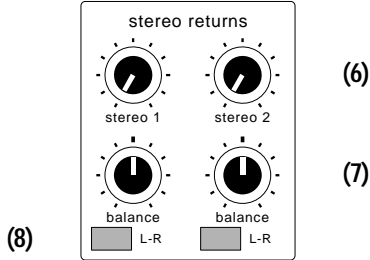
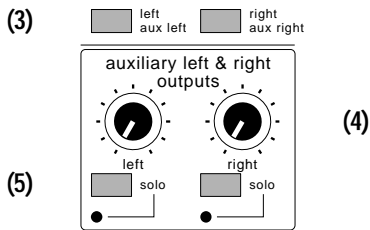
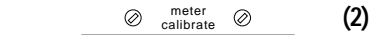
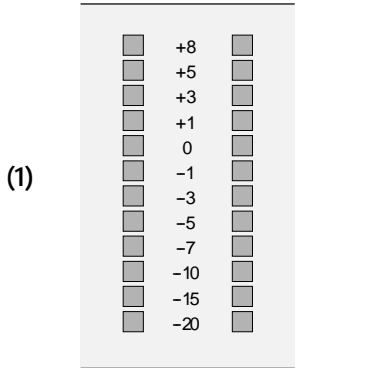

(1) Meters: These twelve-segment, peak reading LED meters display signal level for the Left & Right Main outputs or the Auxiliary Left & Right outputs, depending upon the position of the Meter Select switches (3). Meter readings of "0" indicate output levels of +4dbu. When the red "+8" indicator flashes, 15dB of headroom remains before clipping. Headroom is reduced by 6dB when outputs are used unbalanced. (See Master Connectors on page 12.)

(2) Meter Calibrate: These controls provide screwdriver adjustment of the "0" reference level for each Meter. Meter Calibrate is factory set for +4dBu, but may be adjusted to any reference level from -7dBu to +14dBu.

(3) Left/Aux Left & Right/Aux Right (Meter Select Switches): When released, each switch routes the respective Left or Right Main output signal to that Meter. When either switch is depressed, the respective Auxiliary Left or Right output signal is routed to that Meter. (See Master Connectors on page 12.)

(4) Left & Right (Auxiliary Left & Right Outputs): These controls each adjust the level of pre-fader Left or Right Main signal sent to the respective Auxiliary Left or Right output (see Master Connectors on page 12). These controls also affect signals sent to the Meter Select switches (3) and Solo (5). Auxiliary Left & Right Outputs provide an independently controlled feed for broadcast, recording, control room monitoring, remote sound systems, etc. (See Modifications on page 17.)

(5) Solo: When depressed, each switch routes the respective Auxiliary Left or Right output signal to the Solo System for monitoring (see Master Controls on page 9). The adjacent green LED indicates when Solo is on. Solo signals are affected by the Auxiliary Left & Right Output controls (4).

(6) Stereo 1 & Stereo 2 (Stereo Returns): These controls each adjust the level of signal sent from the respective Stereo 1 or Stereo 2 Return input (see Master Connectors on page 12) to the Left & Right Mains, when selected with the Main Assign switches (8). These controls affect left & right Stereo Return signals equally. Stereo Returns are for auxiliary line level signals, such as effects, tape decks, other mixers, etc.

(7) Balance: These controls each determine the amount of left Stereo Return signal received by the Left Main, versus the amount of right Stereo Return signal received by the Right Main, when selected with the Main Assign switches (8). Balance may be used either to shift left/right positioning of the respective Stereo Return signal within a stereo mix, or simply to attenuate left or right Stereo Return signals.

(8) L-R (Main Assign Switches): When depressed, each switch routes the respective Stereo Return signal to the Left & Right Mains. The Left Main receives left Stereo Return signals only. The Right Main receives right Stereo Return signals only. The amount of left or right Stereo Return signal received by the Left or Right Main is determined by the Balance control (7). The application of these controls is the same as on the Stereo Input Channel (see Stereo Input Channel Controls on page 5).

(9) Left & Right Faders (not shown): These 100mm slide controls each adjust the level of respective Left or Right Main signal sent to the associated Main output, as well as to the Mono Main, the Meter Select switches (3) and the associated Tape output. (See Master Connectors on page 12.) These Faders do not affect the Auxiliary Left & Right Outputs (4) (see Modifications on page 15).

MASTER CONTROLS

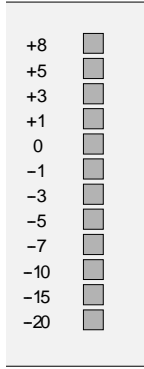

(1)

(1) Meters: This twelve-segment, peak reading LED meter displays signal level for the Mono Main output or the Solo System, depending upon the position of the Meter Select switch (3). Meter readings of "0" indicate output levels of +4dbu. When the red "+8" indicator flashes, 15dB of headroom remains before clipping. Headroom is reduced by 6dB when outputs are used unbalanced. (See Master Connectors on page 12.)



(2)

(2) Meter Calibrate: This control provides screwdriver adjustment of the "0" reference level for the Meter. Meter Calibrate is factory set for +4dBu, but may be adjusted to any reference level from -7dBu to +14dBu.

(3)



(3) Mono/Solo (Meter Select Switch): When released, this switch routes the Mono Main output signal to the Meter (see Master Connectors on page 12). When this switch is depressed, Solo System signal is routed to the Meter.

(5)

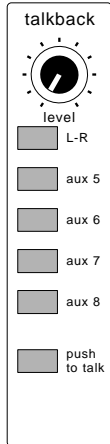

(4)

(4) Level (Talkback): This control provides 30dB of gain adjustment for signal sent from the Talkback Mic input (see Master Connectors on page 12) to the Left & Right Mains and Aux outputs 5-8, which have been selected with the Talkback Assign switches (5) & (6). Talkback allows communication/slating from the mixing console to stage monitors, tape decks, the main sound system, etc.

(5) L-R (Main Assign Switch): When depressed, this switch routes Talkback signal equally to the Left & Right Mains.

(7)

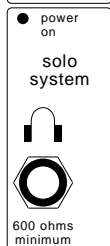

(6) Aux 5, Aux 6, Aux 7, & Aux 8 (Aux Assign Switches): When depressed, these switches route Talkback signal to the respective Aux outputs.

(7) Push-to-Talk: When depressed, this switch turns on Talkback signal sent to the Left & Right Mains and Aux outputs 5-8, which have been selected with the Assign switches (5) & (6). *NOTE: This momentary switch must be held down to activate.*

(9)

(8) Power On: This red LED indicates when power is supplied to the mixing console (see Power Supply on page 13).

(9) (Headphone Output): This 3-conductor 1/4" phone jack is for monitoring Left & Right Main and Solo System signals. The Headphone output is designed for use with 600 ohm headphones. However, by using a special "Patch" cable, it may instead be used to feed a stereo sound system for control room monitoring (see Cables on page 13).

(10)

(10) Headphones: This control adjusts the overall level of signal sent to the Headphone Output. Headphones signal is normally from the Left & Right Main outputs (stereo). However, it is automatically interrupted by signal from any Solo switches which are engaged (mono). Headphones signal is affected by the Left & Right Main Faders and Solo Level (11).

(11)

(11) Solo Level: This control adjusts the level of Solo signal sent to the Headphones. Solo signal is a sum of all signals from channel, submaster, and aux output Solo switches which are engaged. Solo Level is useful to compensate for various Solo signal levels. The adjacent green LED indicates when any Solo switches are engaged. Solo Level does not affect Solo metering. Therefore, Solo (and the Meter Assign switch) may be useful for direct metering of individual channel signals.

mono

(12)

(12) Mono Fader: This 100mm slide control adjusts the level of signal sent to the Mono Main output (see Master Connectors on page 12), as well as to the Meter Select switch (3). The Mono Main signal is a sum of Left & Right Main output signals.

INPUT CHANNEL CONNECTORS

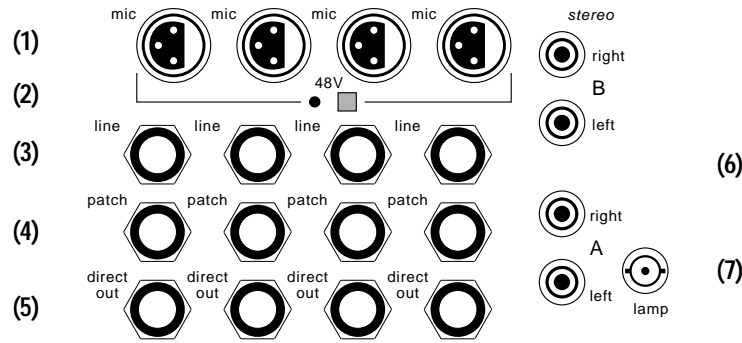

STANDARD INPUT CHANNEL

(1) Mic: These 3-pin XLR jacks are for connection of signals, from low-impedance microphones and direct boxes, to the respective channel inputs. Mic inputs provide a balanced transformerless input wired to DIN standard, with pin 2 high (+), pin 3 low (-), and pin 1 common (ground) (see Cables on page 13). Input transformers are available from Biamp Systems as a user installed option (see Modifications on page 17).

(2) 48V (Phantom Power Switch): When depressed, this switch supplies +48 volts DC to both pins 2 & 3 of the associated Mic jacks. Phantom Power allows operation of condenser microphones and active direct boxes. Normal dynamic microphones will not be affected by the Phantom Power voltage. Phantom Power switches are provided for each group of four Mic inputs. The adjacent red LED indicates when Phantom Power is on (see Power Supply on page 14). **CAUTION:** To avoid possible damage to the sound system, *always turn levels down before switching Phantom Power or making connections to the mixer.*

(3) Line: These 3-conductor 1/4" phone jacks are for connection of signals, from line level devices, to the respective channel inputs. Line level devices include effects units, tape decks, wireless microphones, synthesizers, drum machines, other mixers, etc. Line input jacks provide for proper connection of either balanced (3-conductor) or unbalanced (2-conductor) signals, with Tip high (+), Ring low (-), and Sleeve common (ground) (see Cables on page 13).

(4) Patch: These 3-conductor 1/4" phone jacks are post-EQ/pre-fader insert points, for connection of outboard signal processing devices to the respective channels. Patch jacks are wired with Tip send (output), Ring return (input), and Sleeve common (ground). Special "Patch" cables are required, which allow signal to leave the channel, be processed, and then return to the channel. Patch jacks may also be used as pre-fader direct outputs to feed other devices, such as multi-track tape recorders. To accomplish this, without interrupting the channel signal, connect to Patch with Tip & Ring high (+) and Sleeve common (ground). A standard 2-conductor 1/4" phone cable

may be used to extract signal from Patch, however, this will interrupt the channel signal before it reaches the Fader. (See Cables on page 13.) Patch signals are not affected by the Faders (see Standard Input Channel Controls on page 3).

(5) Direct Out: These 2-conductor 1/4" phone jacks provide unbalanced post-fader output signal from the respective channels. Direct Outs may be useful for connecting individual channels to the inputs of effects devices, multi-track tape recorders, other mixers, etc. Direct Out is wired with Tip high (+) and Sleeve common (ground). Direct Out signals are affected by the respective Faders (see Standard Input Channel Controls on page 3). (See Modifications on page 17.)

STEREO INPUT CHANNEL

(6) A left & right/B left & right (Stereo Inputs): These 2-conductor RCA phono jacks are for connection of stereo signals, from line level devices, to the stereo channel inputs. Line level devices include effects units, tape decks, synthesizers, drum machines, other mixers, etc. Stereo Input jacks provide for proper connection of either balanced (3-conductor) or unbalanced (2-conductor) signals, with Tip high (+) and Sleeve low (-). **NOTE:** When connecting balanced signals, *use only the high (+) and low (-) conductors.* If connection of the common (ground) is necessary, due to increased noise, connect to either chassis or circuit ground (see Power Supply on page 15).

LAMP

(7) Lamp: This 2-conductor BNC connector supplies 12 volts DC (700 mA max.) for use with incandescent or halogen lamps. Lamp connectors are positioned at appropriate intervals along the connector panel. A Lamp On/Off switch (see Master Connectors on page 12) and a Lamp Dimmer control (see Power Supply on page 14) are also provided.

SUBMASTER CONNECTORS

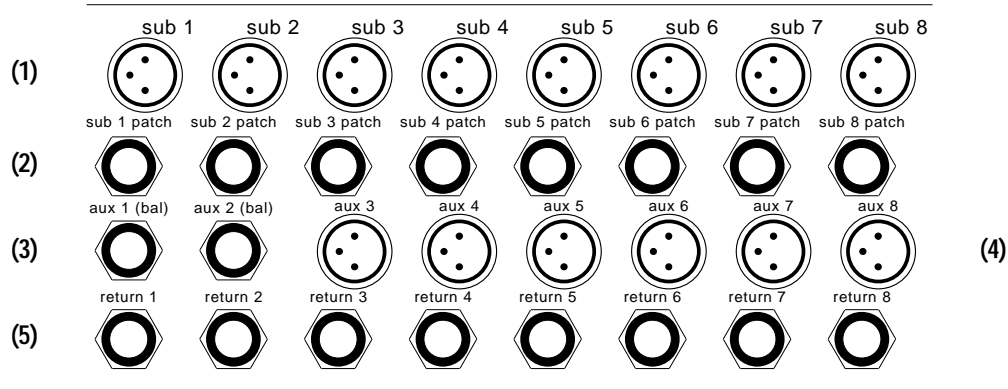

(1) Sub 1-8 (Submaster Outputs): These 3-conductor XLR jacks are for connection of the respective submaster output signals to the inputs of sound system amplifiers, multi-track tape recorders, effects devices, etc. Submaster Outputs are electronically balanced and are wired to DIN standard, with pin 2 high (+), pin 3 low (-), and pin 1 common (ground) (see Cables on page 13). For unbalanced use, wire cables with pin 2 high (+) and both pins 3 & 1 common (ground). Each Submaster Output contains only the channel and return signals which have been assigned to that submaster, as well as any signal processing applied at the respective Sub Patch jack (2). These outputs may be used singularly as individual mono outputs...or...in pairs as stereo outputs...or...when mixing primarily to the Main outputs, Submaster Outputs may not be used at all. The function of these outputs is determined by how signals are assigned to them (see Standard Input Channel Controls on page 3). Submaster Output signals are affected by the respective Mute and Fader functions (see Submaster Controls on page 7).

(2) Sub 1-8 Patch: These 3-conductor 1/4" phone jacks are pre-fader insert points, for connection of outboard signal processing devices to the respective submasters. Sub Patch jacks are wired with Tip send (output), Ring return (input), and Sleeve common (ground). Special "Patch" cables are required, which allow signal to leave the submaster, be processed, and then return to the submaster. Sub Patch jacks may also be used as pre-fader outputs. To accomplish this, without interrupting the submaster signal, connect to Sub Patch with Tip & Ring high (+) and Sleeve common (ground). A standard 2-conductor 1/4" phone cable may be used to extract signal from Sub Patch, however, this will interrupt the submaster signal before it reaches the Fader. (See Cables on page 13.) Sub Patch signals are not affected by the Faders (see Submaster Controls on page 7).

(3) Aux 1 & 2 (bal): These 3-conductor 1/4" phone jacks are for connection of the respective Aux 1 & Aux 2 output signals to the inputs of effects devices, tape decks, stage monitors, other sound systems, etc. Aux 1 & Aux 2 outputs provide proper connection for either balanced (3-conductor) or unbalanced (2-conductor) signals, with Tip high (+), Ring low (-), and Sleeve

common (ground) (see Cables on page 13). Aux 1 & Aux 2 outputs contain only signals from the respective channel aux sends. Aux 1 & Aux 2 output signals are affected by the respective Aux controls (see Submaster Controls on page 6).

(4) Aux 3-8: These 3-conductor XLR jacks are for connection of the respective Aux 3-8 output signals to the inputs of effects devices, tape decks, stage monitors, other sound systems, etc. Aux outputs are electronically balanced and are wired to DIN standard, with pin 2 high (+), pin 3 low (-), and pin 1 common (ground) (see Cables on page 13). For unbalanced use, wire cables with pin 2 high (+) and both pins 3 & 1 common (ground). Aux 3 & Aux 4 outputs contain only signals from the respective channel aux sends. Aux 5-8 outputs contain only signals from the respective channel aux sends and Talkback signals which have been assigned to them. Aux output signals are affected by the respective Aux controls (see Submaster Controls on page 6).

(5) Return 1-8: These 2-conductor 1/4" phone connectors are for connection of unbalanced signals, from line level devices, to the respective Return inputs. Line level devices include effects units, tape decks, wireless microphones, synthesizers, drum machines, other mixers, etc. Returns inputs are wired with Tip high (+) and Sleeve common (ground). Return signal is affected by the respective Return controls (see Submaster Controls on page 6).

MASTER CONNECTORS

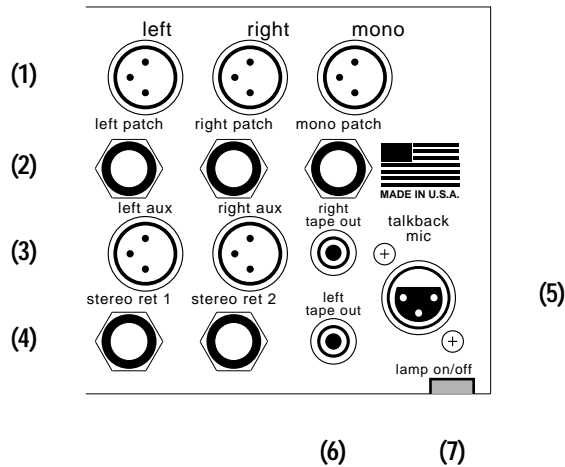

(1) Left, Right, & Mono (Main Outputs): These 3-conductor XLR jacks are for connection of the respective Main output signals to the inputs of sound system amplifiers, tape recorders, etc. Main Outputs are electronically balanced and are wired to DIN standard, with pin 2 high (+), pin 3 low (-), and pin 1 common (ground) (see Cables on page 13). For unbalanced use, wire cables with pin 2 high (+) and both pins 3 & 1 common (ground). The Left & Right Main Outputs contain only the channel, submaster, return, and Talkback signals which have been assigned to them, as well as any signal processing applied at the respective Patch jacks (2). The Mono Main Output contains a sum of all Left & Right Main Output signals, as well as any signal processing applied at the respective Patch jack (2). Typically, the Left & Right Main Outputs are used for stereo applications (recording), and the Mono Main Output is used for mono applications (live sound reinforcement). However, the function of these outputs is determined by how signals are assigned to them (see Standard Input Channel Controls on page 3). Main Output signals are affected by the Faders (see Master Controls on pages 8 & 9).

(2) Left Patch, Right Patch, & Mono Patch (Main Patch): These 3-conductor 1/4" phone jacks are pre-fader insert points, for connection of outboard signal processing to the respective Main Outputs. Main Patch jacks are wired with Tip send (output), Ring return (input), and Sleeve common (ground). Special "Patch" cables are required, which allow signal to leave the respective main, be processed, and then return to that main. Main Patch jacks may also be used as pre-fader outputs. To accomplish this, without interrupting the main signal, connect to a Main Patch with Tip & Ring high (+) and Sleeve common (ground). A standard 2-conductor 1/4" phone cable may be used to extract signal from a Main Patch, however, this will interrupt the main signal before it reaches the Fader. (See Cables on page 13.) Main Patch signals are not affected by the Faders (see Master Controls on pages 8 & 9).

(3) Left Aux & Right Aux: These 3-conductor XLR jacks are for connection of the respective Left Aux & Right Aux output signals to the inputs of sound system amplifiers, tape recorders,

etc. Left Aux & Right Aux outputs are electronically balanced and are wired to DIN standard, with pin 2 high (+), pin 3 low (-), and pin 1 common (ground) (see Cables on page 13). For unbalanced use, wire cables with pin 2 high (+) and both pins 3 & 1 common (ground). Each Left Aux & Right Aux output contains only pre-fader signal from the respective Left & Right Main (see Modifications on page 17). These are independently controlled outputs. Therefore, they may be used as a feed for broadcast, recording, or other sound systems, while the Left & Right Main Outputs continue to feed the main sound system. Left Aux & Right Aux output signals are affected by the Auxiliary Left & Right Output controls (see Master Controls on page 8).

(4) Stereo Return 1 & Stereo Return 2: These 3-conductor 1/4" phone jacks are for connection of unbalanced stereo signals, from line level devices, to the respective Stereo Return inputs. Line level devices include effects units, tape decks, synthesizers, drum machines, other mixers, etc. Stereo Return inputs are wired with Tip left input (+), Ring right input (+), and Sleeve common (ground). Special "Patch" cables are required, which allow both left & right input signals to be connected to these stereo jacks. For mono use, wire cables with both Tip & Ring high (+) and Sleeve common (ground). *CAUTION: Standard 2-conductor 1/4" phone cables will apply signal only to the left side of these connectors.* (See Cables on page 13.) Stereo Return signals are affected by the Stereo Return controls (see Master Controls on page 8).

(5) Talkback Mic: This 3-conductor XLR jack is for connection of signal, from a low-impedance dynamic microphone, to the Talkback input. Talkback Mic provides a balanced transformerless input wired to DIN standard, with pin 2 high (+), pin 3 low (-), and pin 1 common (ground) (see Cables on page 13). Talkback Mic allows communication through the Main and Aux 5-8 outputs. Therefore, a person at the mixer may communicate with someone via the monitor system...or...make announcements through the main sound system...or...add slate comments to tape recordings. Talkback signal is affected by the Talkback controls (see Master Controls on page 9).

(6) Left & Right Tape Outputs: These 2-conductor RCA phono jacks provide unbalanced post-fader output signals from the respective Left & Right Mains, and are wired with Tip high (+) and Sleeve common (ground). Left & Right Tape Output signals have a nominal level of -10dB, suitable for cassette decks and other consumer equipment.

(7) Lamp On/Off: When depressed, this switch supplies voltage (+12VDC @ 700mA max.) to the Lamp connectors (see Input Channel Connectors on page 10). Lamp voltage is also affected by the Lamp Dimmer (see Power Supply on page 14).

CABLES

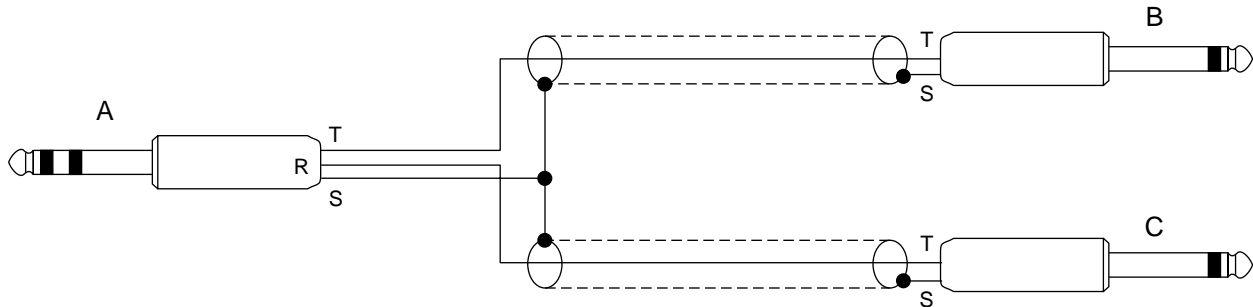

Patch Cable: This type of cable uses a Tip/Ring/Sleeve 1/4" phone connector on one end and Tip/Sleeve 1/4" phone (or RCA phono) connectors on the other two ends. It is wired with Tip A to Tip B, Ring A to Tip C, and Sleeve A to Sleeve B & C (ground). When connected to a channel Patch jack, Tip B is the send (output) and Tip C is the return (input) of the channel. When used to provide a stereo line output from the Headphone jack, Tip B is the Left output and Tip C is the Right output. When used to provide a stereo line input to either the Stereo Return 1 jack or the Stereo Return 2 jack, Tip B is the Left input and Tip C is the Right input.

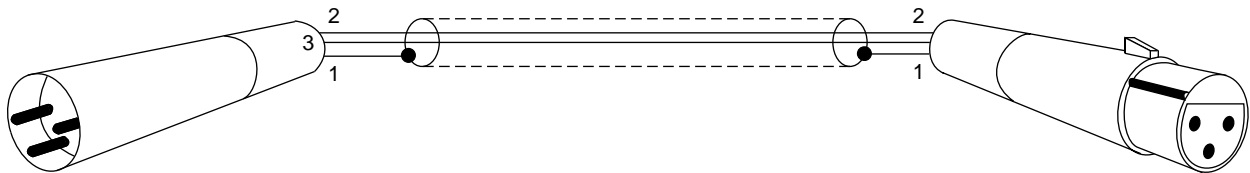

Balanced XLR Cable: This type of cable uses a male XLR connector on one end and a female XLR connector on the other end. It is wired with Pin 2 to Pin 2 (+), Pin 3 to Pin 3 (-), and Pin 1 to Pin 1 (ground). Use these cables when connecting *balanced* signals at channel Mic inputs or Submaster, Main, and Aux 3-8 outputs. When connecting *unbalanced* signals, wire cables with Pin 2 (+) and both Pins 3 & 1 (ground). For proper connection to outboard equipment, it may be necessary to use a Tip/Ring/Sleeve 1/4" phone connector on one end of the cable, wired with Pin 2 to Tip (+), Pin 3 to Ring (-), and Pin 1 to Sleeve (ground). For *unbalanced* signals, use a Tip/Sleeve connector wired with Pin 2 to Tip (+) and both Pins 3 & 1 to Sleeve (ground).

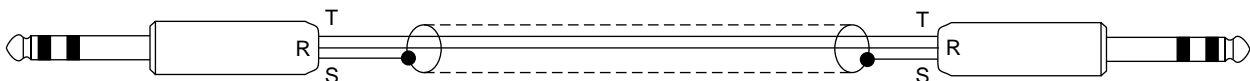

Balanced 1/4" Phone Cable: This type of cable uses Tip/Ring/Sleeve connectors on each end and is wired with Tip to Tip (+), Ring to Ring (-), and Sleeve to Sleeve (ground). Use these cables when connecting *balanced* signals at channel Line inputs or Aux 1 & 2 outputs. For proper connection to outboard equipment, it may be necessary to use an XLR connector on one end of the cable, wired with Tip to Pin 2 (+), Ring to Pin 3 (-), and Sleeve to Pin 1 (ground).

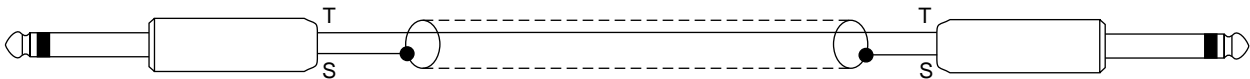

Unbalanced 1/4" Phone Cable: This type of cable uses Tip/Sleeve connectors on each end and is wired with Tip to Tip (+) and Sleeve to Sleeve (ground). Use these cables when connecting *unbalanced* signals at channel Line inputs, channel Direct Outs, Aux 1 & 2 outputs, or Return 1-8 inputs. This type of cable may also be used to extract signal from any Patch jack, however, *this will interrupt signal before it reaches the fader*. For proper connection to outboard equipment, it may be necessary to use an RCA phono connector on one end of the cable (wiring is the same). RCA phono connectors may be used at both ends of this type of cable, for connection of *unbalanced* signals at the stereo channel inputs and Tape Out Left & Right.

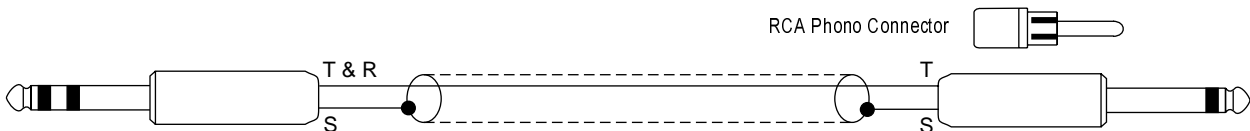

Tip/Ring/Sleeve to Tip/Sleeve 1/4" Phone Cable: This type of cable uses a Tip/Ring/Sleeve 1/4" phone connector on one end and a Tip/Sleeve 1/4" phone connector on the other end. It is wired with Tip & Ring to Tip (+) and Sleeve to Sleeve (ground). Use this cable to extract signal from any Patch jack, *without interrupting signal*. This allows Patch jacks to be used as pre-fader direct outputs. For proper connection to outboard equipment, it may be necessary to use an RCA phono connector on one end of the cable.

POWER SUPPLY

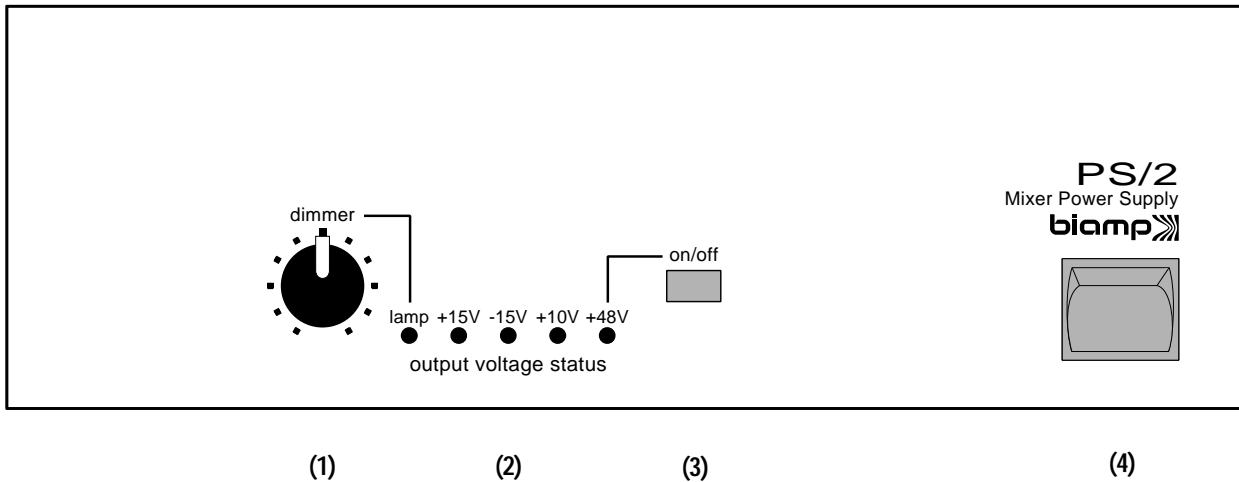

(1) Dimmer: This control adjusts the amount of voltage sent to the Lamp connectors (see Input Channel Connectors on page 11). With the Dimmer control set fully clockwise, maximum voltage (+12 volts DC @ 700 mA) is sent to the lamps, for full brightness. When this control is rotated counter-clockwise, voltage and brightness of the lamps are reduced (+6 volts min.). The adjacent Lamp LED also dims as voltage is reduced. This voltage allows use of incandescent or halogen lamps. Lamp voltage is affected by the Lamp On/Off switch (see Master Connectors on page 12).

(2) Output Voltage Status Indicators: These five LEDs indicate the status of the respective voltages. The green Lamp LED indicates when the Lamp voltage is operational, and will become dim as Lamp voltage is reduced with the Dimmer control. The green +15V & -15V LEDs indicate when the respective voltages are within +/-10% of nominal (+/-15 volts DC @ 2A max.). These voltages operate all signal oriented circuitry within the mixing console. The green +10V LED indicates when the respective voltage is operational (+10 volts DC @ 800 mA max.). This voltage operates all LED circuitry within the mixing console. The red +48V LED indicates when the Phantom Power voltage is operational (+48 volts DC @ 325 mA max.).

The +48V LED is affected by the respective On/Off switch (3) and will come on and go off gradually, due to the "ramping" on/off function of this voltage. *NOTE: If any of the Output Voltage Status Indicators should fail to light, or do not reach full brightness, there may be a voltage problem. Under these circumstances, the mixing console may continue to operate. Check all connections, controls, and switches. If no problem is located, the power supply and/or mixing console may require service.*

(3) +48V On/Off Switch (Phantom Power): When depressed, this switch turns on the +48 volt Phantom Power voltage. Phantom Power voltage is sent to the channel Mic inputs for operation of condenser microphones and direct boxes (see Input Channel Connectors on page 11). This voltage has a gradual on/off function to protect associated equipment from transients. *CAUTION: To avoid possible damage to the sound system, always turn levels down before switching Phantom Power or making connections to the mixer.*

(4) Power Switch: This switch turns on the Power Supply and applies power to the mixing console.

POWER SUPPLY

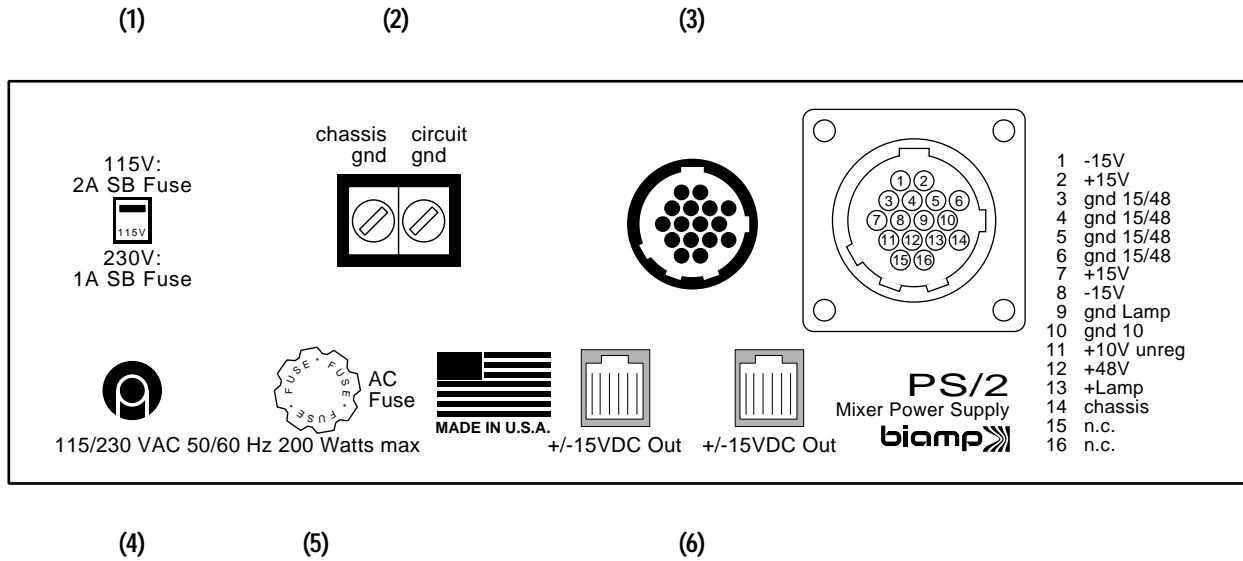

(1) Voltage Selector Switch: This switch is factory set to "115V" for operation with line voltages of 110-120VAC. For operation with line voltages of 220-240VAC, set this switch to "230V" and replace the AC Fuse (5) with a 1A SB fuse (accessory item included with power supply).

(2) Chassis Gnd/Circuit Gnd Strap: This strap, and the associated two terminals, connect Chassis Ground and Circuit Ground together. If a circuit ground reference is provided by other equipment in the system, removal of this strap may help prevent hum due to "ground loops". These terminals may also be used as a grounding point for other equipment in the system, such as *balanced stereo inputs* (see Stereo Input Channel Connectors on page 10).

(3) Power Supply Cable Connector: This multi-pin receptacle is for connection of the Power Supply cable. A similar receptacle is provided on the right side of the mixing console. The cable delivers the operational DC voltages from the Power

Supply to the mixing console. These receptacles and the associated cable are designed to connect one way only, preventing any mis-connections.

(4) AC Power Cord: This cable is for connection to a three prong grounded AC outlet. *CAUTION: Do not remove or defeat the AC ground prong on the plug, as this constitutes a shock hazard.*

(5) AC Fuse: Replace the AC Fuse only with the same value and type (2A SB for 115V operation or 1A SB for 230V operation). If the AC Fuse continues to blow, the power supply and/or mixing console may require service.

(6) DC Out: Each of these modular jacks provide +/-15 volts DC (300mA max.) to power external devices. Contact Biamp Systems for technical data, pin orientation, or information on associated products.

MODIFICATIONS

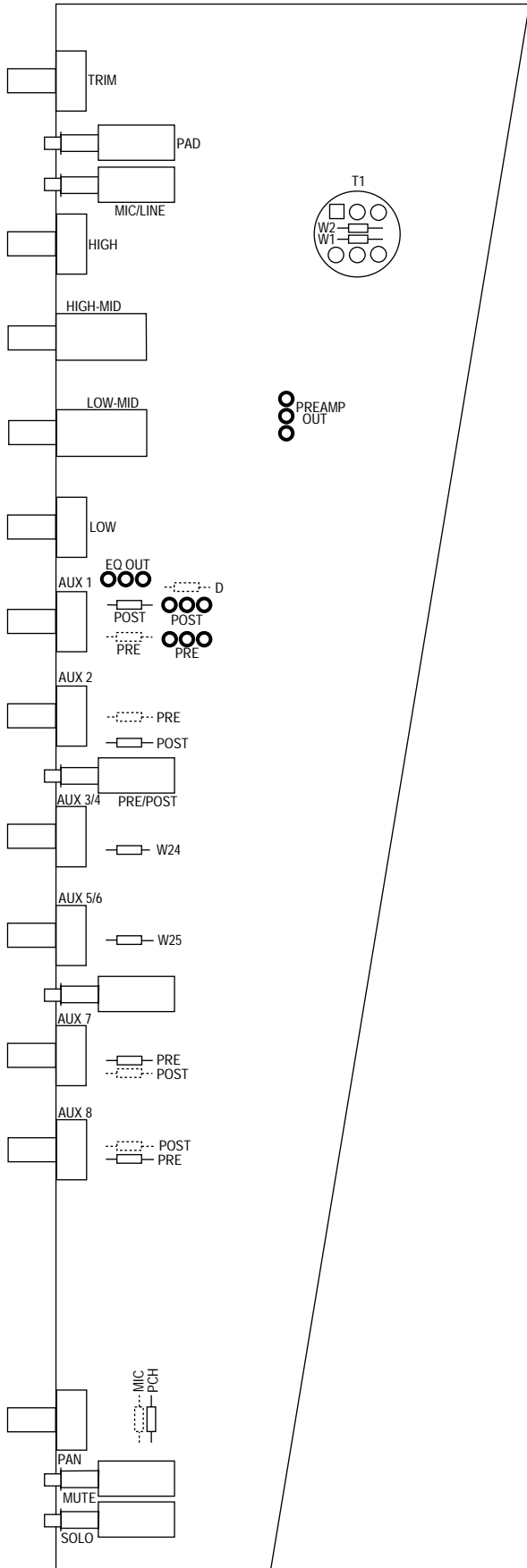

Diagram A

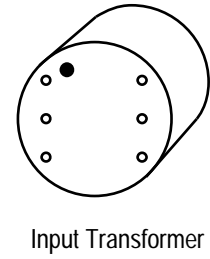
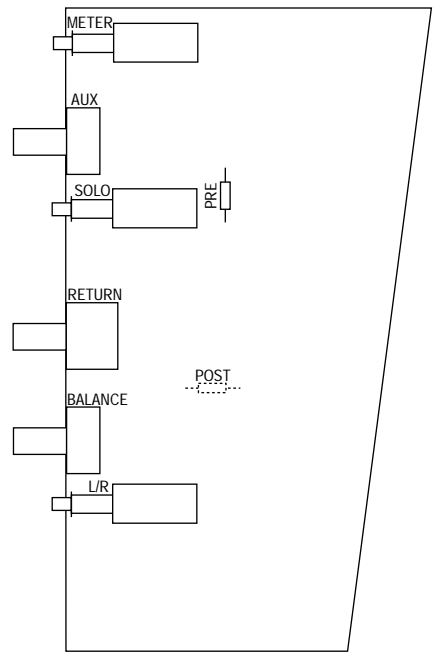

Diagram B



MODIFICATIONS

INPUT TRANSFORMERS

Input transformers are available from Biamp Systems as a user installed option. To install input transformers, first locate the transformer position (T1) on the desired channel circuit boards (see Diagram A). Remove both jumpers (W1 & W2). Clear solder from the six transformer mounting holes. Insert the six transformer pins into the mounting holes, making certain that pin #1 (black dot) is in hole #1 (square). Then solder the transformer pins to the respective solder pads on the rear of the circuit board. *NOTE: If necessary, clip excess pin length, being careful to remove clippings from the mixer.*

AUX SENDS

Post-Fader or Pre-Fader: Aux Sends 1 & 2 are factory set for post-fader operation. Aux Sends 7 & 8 are factory set for pre-fader operation. These sends may be individually modified on the channels. On the channel circuit boards, directly behind each of these Aux Send controls, there are two jumper positions (see Diagram A). One position is labelled "PRE" (pre-fader) and the other is labelled "POST" (post-fader). Only one position is occupied with a jumper. To modify a given channel Aux Send, clear solder from the mounting holes at both jumper positions, move the jumper to the desired position, and solder the jumper leads to the solder pads on the rear of the circuit board.

Pre-Fader or Pre-EQ: The jumper positions labelled "PRE", as described above, provide pre-fader channel signal. These "PRE" jumper positions, *as well as the "PRE" position of the Aux 3,4 & Aux 5,6 Post/Pre switches*, may be modified to provide pre-EQ channel signal. On the channel circuit boards, directly behind the Pan controls, there are two jumper positions (see Diagram A). One position is labelled "MIC" for microphone preamplifier (pre-EQ) and the other is labelled "PCH" for patch return (pre-fader). Only the "PCH" position is occupied with a jumper (factory set for pre-fader). To modify a given channel for pre-EQ, clear solder from the mounting holes at both jumper positions, move the jumper to "MIC" position, and solder the jumper leads to the solder pads on the rear of the circuit board.

Wiring Pads: Four "wiring pads" are provided on each channel circuit board, for more complex modifications. Each wiring pad consists of three wire mounting holes and solder pads. These wiring pads are labelled "PREAMP OUT", "EQ OUT", "PRE", and "POST" (see Diagram A). They provide a source for all possible channel signal points: {"PREAMP OUT" = pre-EQ} {"EQ OUT" = post-EQ /pre-Patch} {"PRE" = pre-fader/post-patch} {"POST" = post-fader}. Any of these wiring pads may be used to supply signal to individual channel Aux Sends. To accomplish this, first remove the pre or post jumper for the respective Aux Send, as described above. (For Aux Sends 3/5 or 4,6 remove jumper W24 or W25 respectively. Jumpers W24 & W25 remove Aux Sends 3,5 & 4,6 from the Post/Pre switch.) (see Diagram A). Then insert one end of a wire into the appropriate wiring pad and solder. The other end of the wire should be soldered to the vacant jumper position for the desired Aux Send, *at the mounting hole nearest to the front panel*. For best results, use just the necessary length of high quality 22 gauge insulated wire. Other "wiring pad" modifications include changing the signal source for channel Patch and Direct Out. However, these modifications are more advanced and require schematic diagrams and technical assistance from Biamp Systems.

AUXILIARY LEFT & RIGHT OUTPUTS

The Auxiliary Left & Right Outputs are factory set to receive pre-fader signals from the Left & Right Mains (which allows independent level control). These outputs may be individually modified, on the respective circuit boards, to receive post-fader signals from the Left & Right Mains (allowing these outputs to reflect Left & Right Main Fader adjustments). On each Left & Right Main circuit board there are two jumper positions. One position is directly behind the Solo switch, and is labelled "PRE" (pre-fader). The other position is behind the Balance control, and is labelled "POST" (post-fader). (See Diagram B). Only the "PRE" position has a jumper installed (factory set for pre-fader). To modify either Auxiliary Output for post-fader, clear solder from the mounting holes at both jumper positions, move the jumper to the "POST" position, and solder the jumper leads to the solder pads on the rear of the circuit board.

CAUTION: *Modifications should be performed by a qualified technician. To avoid damage, do not use excessive heat or solder.*

SPECIFICATIONS

MICROPHONE PREAMPLIFIERS:

Frequency Response (20Hz-20kHz, +4dBu out) +0/-5dB
 Total Harmonic Distortion
 (20Hz-20kHz, 40dB gain, +4dBu out) <.01%
 Intermodulation Distortion (SMPTE) <.02%
 Equivalent Input Noise
 (20Hz-20kHz, 150 ohm termination) -128dBu
 Maximum Gain (mic input) 53dB
 Maximum Gain (line input) 25dB
 Trim Control Range 40dB
 Input Impedance (mic/balanced) 2k Ω
 Input Impedance (line/balanced) 20k Ω
 Maximum Input (mic) +27dBu
 Maximum Input (line) +27dBu
 Phantom Power +48 Volts DC (325 mA max.)

INPUT CHANNEL EQUALIZATION:

High EQ +/-12dB @ 10kHz (shelving)
 High-Mid EQ +/-12dB @ 200Hz-10kHz (peaking)
 Low-Mid EQ +/-12dB @ 100Hz-5kHz (peaking)
 Low EQ +/-12dB @ 100Hz (shelving)

STEREO INPUT CHANNEL:

Frequency Response (20Hz-20kHz, +4dbu out) +0/-5dB
 Total Harmonic Distortion
 (20Hz-20kHz, 10dB gain, +4dBu out) <.01%
 Intermodulation Distortion (SMPTE) <.02%
 Input Impedance (line/balanced) 12.5k Ω
 Maximum Gain 20dB
 Trim Control Range 20dB
 Maximum Input +21dBu
 High EQ +/-15dB @ 10kHz
 Low EQ +/-15dB @ 100Hz

MIXER SECTION:

Frequency Response (20Hz-20kHz, +4dBu out) +0/-1dB
 Total Harmonic Distortion
 (20Hz-20kHz, unity gain, +4dBu out) <.01%
 Intermodulation Distortion (SMPTE) <.02%
 Noise Floor
 (submaster/main outputs, 0Hz-30kHz, unity gain) -88dBu
 Crosstalk (channel-to-channel @ 1kHz) -77dB
 Crosstalk (channel-to-channel @ 10kHz) -77dB
 Crosstalk (submaster-to-submaster @ 1kHz) -77dB
 Crosstalk (submaster-to-submaster @ 10kHz) -50dB
 Input Impedance (returns/unbalanced) 20k Ω
 Input Impedance (patch/unbalanced) 20k Ω
 Output Impedance (sends, subs, & mains/balanced) 100 Ω
 Output Impedance (patch/unbalanced) 100 Ω
 Output Impedance (tape/unbalanced) 1k Ω
 Maximum Output (sends, subs, & mains/balanced) +27dBu
 Maximum Output (patch/unbalanced) +21dBu
 Maximum Output (tape/unbalanced) +8dBu
 Maximum Output (headphones/each side) +18dBm
 Minimum Load Impedance (sends, subs, & mains) 600 Ω
 Minimum Load Impedance (patch) 2k Ω
 Minimum Load Impedance (tape) 5k Ω
 Minimum Load Impedance (headphones/each side) 600 Ω

AC POWER REQUIREMENTS

(115/230VAC @ 50/60Hz) 200 Watts

DIMENSIONS:

	<u>24 channel</u>	<u>32 & 40 channel</u>
Height	6 inches	6 inches
Width	46 inches	63.25 inches
Depth	30 inches	30 inches

WEIGHT:

	<u>24 channel</u>	<u>32 channel</u>	<u>40 channel</u>
	85 lbs.	115 lbs.	120 lbs.

COLUMBIA BLOCK DIAGRAM

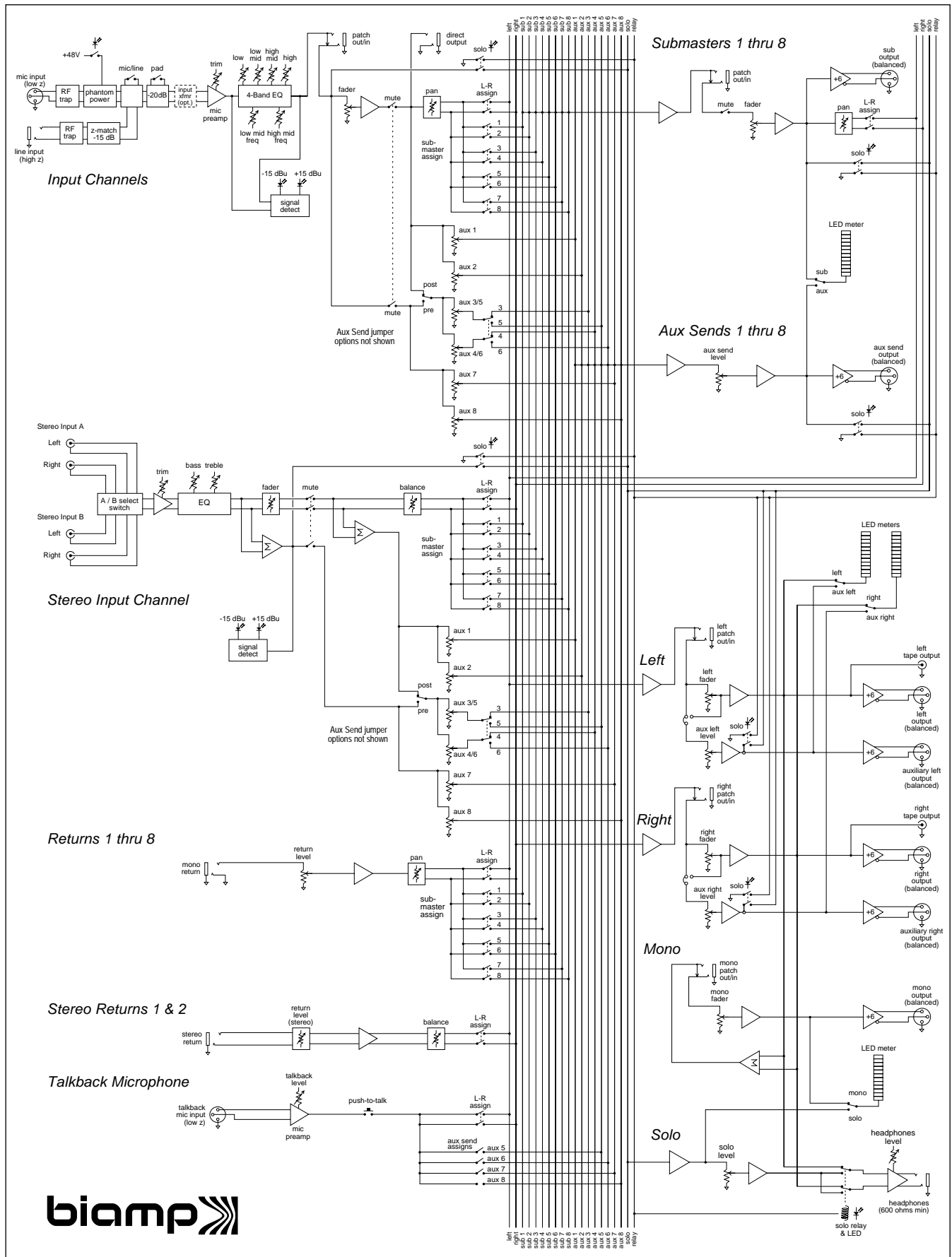

WARRANTY

BIAMP IS PLEASED TO EXTEND THE FOLLOWING 1-YEAR LIMITED WARRANTY TO THE ORIGINAL PURCHASER OF THE PROFESSIONAL SOUND EQUIPMENT DESCRIBED IN THIS OWNER'S MANUAL.

BIAMP Systems expressly warrants this product to be free from defects in material and workmanship for a period of 1 YEAR from the date of purchase as a new product from an authorized BIAMP dealer under the following conditions.

1. The Purchaser is responsible for completing and mailing to BIAMP, within 10 days of purchase, the attached warranty application.

2. In the event the warranted BIAMP product requires service during the warranty period, BIAMP will repair or replace, at its option, defective materials, provided you have identified yourself as the original purchaser of the product to any authorized BIAMP Service Center. Transportation and insurance charges to and from an authorized Service Center or the BIAMP factory for warranted products or components thereof to obtain repairs shall be the responsibility of the Purchaser.

3. This warranty will be VOIDED if the serial number has been removed or defaced; or if the product has been subjected to accidental damage, abuse, rental usage, alterations, or attempted repair by any person not authorized by BIAMP to make repairs; or if the product has been installed contrary to BIAMP's instructions.

4. The normal wear and tear of appearance items such as paint, knobs, handles, and covers is not covered under this warranty.

5. BIAMP SHALL NOT IN ANY EVENT BE LIABLE FOR SPECIAL, INCIDENTAL, OR CONSEQUENTIAL DAMAGES, INCLUDING LOST PROFITS, LOSS OF USE, PROPERTY DAMAGE, INJURY TO GOODWILL, OR OTHER ECONOMIC LOSS OF ANY SORT. EXCEPT AS EXPRESSLY PROVIDED HEREIN, BIAMP DISCLAIMS ALL OTHER LIABILITY TO PURCHASER OR ANY OTHER PERSONS ARISING OUT OF USE OR PERFORMANCE OF THE PRODUCT, INCLUDING LIABILITY FOR NEGLIGENCE OR STRICT LIABILITY IN TORT.

6. THIS WARRANTY IS IN LIEU OF ALL OTHER WARRANTIES EXPRESSED OR IMPLIED. BIAMP EXPRESSLY DISCLAIMS ALL IMPLIED WARRANTIES OF MERCHANTABILITY AND FITNESS FOR A PARTICULAR PURPOSE. THE REMEDIES SET FORTH HEREIN SHALL BE THE PURCHASER'S SOLE AND EXCLUSIVE REMEDIES WITH RESPECT TO ANY DEFECTIVE PRODUCT. THE AGENTS, EMPLOYEES, DISTRIBUTORS, AND DEALERS OF BIAMP ARE NOT AUTHORIZED TO MODIFY THIS WARRANTY OR TO MAKE ADDITIONAL WARRANTIES BINDING ON BIAMP. ACCORDINGLY, ADDITIONAL STATEMENTS SUCH AS DEALER ADVERTISEMENTS OR REPRESENTATIONS DO NOT CONSTITUTE WARRANTIES BY BIAMP.

7. No action for breach of this warranty may be commenced more than one year after the expiration of this warranty.

Thank you for purchasing BIAMP...
AMERICAN SOUND CRAFTSMANSHIP

Biamp Systems
14130 N.W. Science Park
Portland, Oregon 97229
(503) 641-7287